

Unopex UHM 20 Vacuum Mixer



Table of Contents

1.	Introduction	1
1.1	Details on the Declaration of Conformity	1
1.2	Safety	1
1.2.1	Symbols Used for Safety Instructions.....	1
1.2.2	Proper Use.....	3
1.2.3	Improper Use	4
1.2.4	General Hazards and Safety Notices.....	5
1.2.5	Further Protective Safety Measures.....	7
1.3	Staff Qualification.....	7
1.3.1	Responsible Body	7
1.3.2	Operators.....	8
2.	Technical Details.....	9
2.1	Scope of Delivery	9
2.2	Technical Data	10
2.3	Material of Construction.....	10
3.	Plant Description	11
3.1	Overview	11
3.2	External Connections.....	12
3.3	Control Cabinet.....	12
4.	Preparations Before Operation	13
4.1	Un-packing	13
4.2	Ambient & Installation Conditions	14
4.3	Connecting to the Power Supply.....	14
5.	Operation	15
5.1	Final Check Before Operation	15
5.2	Introducing Operating Elements	16
5.2.1	Homogenizer	16
5.2.2	Internal and External Mixers.....	16
5.2.3	Heating and Cooling System.....	16
5.2.4	Vacuum System	16
5.3	Introducing Operating Panel	17
5.4	Introducing Touchscreen Operation	18
5.5	Starting a Vacuum Mixing Operation.....	21
5.6	Finishing a Vacuum Mixing Operation and Draining the Product.....	22

5.7	Cleaning.....	23
6.	Maintenance and Repairs.....	24
6.1	Customer Service.....	25
7.	Troubleshooting.....	26
7.1	Alarm Messages and Remedy	26
7.2	Malfunctions and Remedy	31
8.	Taking Out of Operation	32
8.1	Storage, Packing and Transport	32
8.2	Disposal	32
9.	Declaration of Conformity.....	33

Foreword

Dear Customer,

Thank you for choosing Unopex UHM 20 Vacuum Mixer. You have made a good choice. Thank you for your trust.

Please read this manual carefully, note the safety precautions before installing and putting the Unopex UHM 20 Vacuum Mixer into operation. You will find all necessary information for the safe operation of the plant in this manual.

Follow this manual with regard to installation, start-up, operation, cleaning, maintenance, repair, storage and disposal of the plant.

Data in this manual are subject to change without notice.

Please remember that this manual is copyright. Any information in this manual may not be reproduced, distributed or used for competitive purposes, nor made available to third parties. The manufacture of any component with the aid of this manual is also prohibited.

1. Introduction

1.1 Details on the Declaration of Conformity





The plant complies with the requirements of the European Directives: 2006/42/EC (Machinery Directive) and 2014/35/EU (Low Voltage Directive).

1.2 Safety













The safety information in this operation manual is designed to protect the responsible body, operator and the plant from damage.

1.2.1 Symbols Used for Safety Instructions

Safety instructions are marked by the below combinations of pictograms and signal words. The signal word describes the classification of the residual risk when disregarding this manual.

	Denotes an immediate hazardous situation that will result in death or serious injuries.
	Denotes a general hazardous situation that may result in death or serious injuries.
	Denotes a hazardous situation that can result in injuries.
NOTE	Denotes a situation that can result in property material damage.
INFORMATION	Denotes important notes and usable hints.

Below are the supplementary safety information symbols and meanings used in this manual.

 <p>General warning</p>	 <p>Electrical hazard</p>
 <p>Hot surfaces</p>	 <p>Fragile components</p>
 <p>Explosive gases Explosive environments</p>	 <p>Harmful to health and life</p>
 <p>Risk of injuries of the limbs</p>	 <p>Risk by chemicals</p>
 <p>Wear protective goggles</p>	 <p>Wear protective cloth</p>
 <p>Wear protective gloves</p>	 <p>Wear protective mask</p>
 <p>Wash your hands</p>	

1.2.2 Proper Use

The technical specifications of the plant is given in Section-2.

Unopex UHM 20 Vacuum Mixer has been designed and manufactured for mixing of products that come up with various degree of viscosity under reduced atmospheric pressure.

It is appropriate for batch production of emulsions, syrups, lotion, skin care products, ointment, semisolids and creams in pharmaceutical, cosmetics, food and chemical industries.

Installation, operation, service and maintenance works must be performed according to the instructions in this manual. Failure to comply with the manual is deemed improper use and will result in loss of warranty.



Using the plant in potentially explosive environments

DEATH OR SERIOUS INJURIES THROUGH EXPLOSION

- The plant is not explosion-proof. Never use it in areas which require ex-protected instruments or plants
- Do not install or start up the plant in explosive environments
- Do not operate the plant with explosive gas mixtures
- Ensure sufficient ventilation to directly withdraw released gases and gaseous substances



Improper use

SERIOUS INJURY AND PROPERTY DAMAGE

- Store the operation manual where it is easy to access in close proximity to the plant
- Only adequately qualified operators may work with the plant
- Operators must be trained before handling the plant
- Check that the operators have read and understood the operation manual
- Define precise responsibilities of the operators
- Personal protective equipment must be provided to the operators
- Handle and dispose the substances used for operation and cleaning of the plant correctly
- Be sure to follow the **responsible body's** safety rules

NOTE

Modifications to the plant by third-parties

DAMAGE TO THE PLANT

- Do not allow third parties to make technical modifications to the plant
- Modifications to the plant are only permitted with the written approval of the manufacturer
- Modifications and upgrades shall only be carried out by an authorized Unopex specialist. The manufacturer will decline any claim resulting from unauthorized modifications.
- In case of any modification of the plant not approved by the manufacturer, the CE declaration of conformity becomes invalid.
- Only specialists trained by the manufacturer may carry out start-up, service, repairs or maintenance work.
- Only use the plant in a fault-free conditions!
- Do not ignore, bypass, dismantle or disconnect any safety devices!

1.2.3 Improper Use

Unopex UHM 20 Vacuum Mixer is permitted only for the purposes for which it was manufactured. Risks to users, property and the environment can arise when the plant is damaged, used carelessly or improperly.

Use of the plant for purposes other than the ones mentioned or beyond specified use limits shall relieve the manufacturer of all responsibility in case of damage to persons or things and invalidate the warranty.



The manufacturer accepts no liability for damage caused by technical modifications to the plant, improper handling or use of if the operation manual is not observed.

Below uses are expressly forbidden:

- use of the plant by insufficiently trained personnel
- use of the plant for the applications not specified in Section 1.2.2
- use of substances with unknown chemical composition
- use of the plant in areas which require ex-protected instruments
- use of the plant without genuine parts and genuine consumables
- use of the plant with deactivated, modified or defect safety devices
- use of biohazardous materials or toxic substances
- use of substances which might explode or ignite
- use of substances which become solid in the plant due to the processing
- use of corrosives or substances which are not compatible with the plant materials
- unattended operation
- use of media containing chlorine

1.2.4 General Hazards and Safety Notices



 **DANGER** Risk by electrical voltage and current

DEATH OR SERIOUS INJURY OR PROPERTY DAMAGE

- External mains supply must always meet the plant specifications
- Check for sufficient grounding
- Check electrical equipment regularly
- Keep all parts of body and any hand-held tools or other conductive objects away from exposed live parts of electrical system
- Keep all electrical utilities and control cabinet always closed
- Do not clean electrical equipment with water or any unknown liquids
- Do not use the power cord if it is bundled or tangled
- Exchange defective or worn out wires or lines immediately

 **DANGER** Working with harmful or hazardous substances or with substances of unknown composition











DEATH OR SERIOUS INJURY THROUGH EXPLOSION

DEATH OR SERIOUS POISONING BY CONTACT OR INCORPORATION

- Certain gases in or in the vicinity of the plant are highly inflammable
- Always be aware of the poisoning and explosion risk for harmful or hazardous substances
- Never use explosive substances, flammable substances and substances that include explosive or flammable ingredients
- Never work with substances of unknown composition
- Before operation, check the plant for correct installation and assembling
- Before operation, inspect parts, components, sealings for good condition
- Exchange defective or worn out parts immediately
- Clean or exchange clogged parts immediately
- Directly withdraw released gases and gaseous substances by sufficient ventilation
- Check for leakages by performing an initial run without sample material
- Switch off main switch of the plant immediately in case of fire
- Only operate the plant in sufficiently ventilated environments

 **DANGER** Incorporation or inhalation of hazardous, gases, liquid, steam, vapors, fog and dust

DEATH OR SERIOUS POISONING BY INCORPORATION OR INHALATION

- Do not inhale hazardous substances
- Wear protective clothing
- Wear protective gloves
- Wear protective eye goggles
- Wear protective mask
- Wear non-slip shoes
- Check all parts for proper sealing before operation
- Always provide sufficiently ventilated environments to operate the plant
- Do not use compressed air to clean dusty parts
- Ensure an eye shower at the operating area
- All possibly hazardous substances and fumes have to be removed from the working area
- Exhausts leaving the plant have to be lead away instantly by a ventilation system which is equipped with safety devices and equipments to avoid health risk or contamination of the environment

 **DANGER**



Internal overpressure

SERIOUS INJURY AND PROPERTY DAMAGE

- External pressure supply must always meet the plant specifications
- Check all parts, connections and sealings for proper sealing before operation
- Do not use clogged parts, clean or exchange them immediately
- Do not open any valve when there is a residual pressure inside the plant
- Close valves and clamp connections which are not necessary during operation with blind components.

 **DANGER**



Inhalation of inert gases

DEATH BY SERIOUS POISONING OR SUFFOCATION

- Only operate the plant in sufficiently ventilated environments
- Do not inhale inert gases
- Ensure sufficient ventilation to directly withdraw released gases and gaseous substances
- Check all parts, connections and sealings for proper sealing before operation
- Exchange defective or worn out parts immediately

 **WARNING**



Operation with bent hoses

SERIOUS INJURY AND PROPERTY DAMAGE

- Always inspect the plant for bends or kinks in hoses
- Eliminate them prior to operation

 **CAUTION**



Handling hot surfaces

RISK OF BURNINGS WHEN HANDLING HOT SURFACES

- Do not touch hot surfaces
- Always wear proper personal protective equipments when working with the plant
- Allow all hot parts to cool down after operation

 **CAUTION**



Always wear the following personal protective equipments when working with the plant

- protective clothing
- protective gloves
- protective eye goggles
- protective mask

Depending on operating conditions, noise levels might arise which can lead to deafness, loss of balance or reduced attention. Consider local noise regulations and use the proper personal protective equipment for ears.

NOTE



Liquid spill

PROPERTY DAMAGE

- Do not put any liquid sample vessel on any component of the plant
- Do not spill any liquids over the control cabinet, plant or any parts of it
- Do not allow any liquid to leak into the control cabinet
- Wipe off any liquids immediately
- Always be aware of the risk of plant short-circuits and damage by liquids
- Do not move the plant when it is loaded with liquid

1.2.5 Further Protective Safety Measures

INFORMATION

Emergency strategy

Disconnect the plant from the power supply!

Warnings/alarm messages on the touchscreen operating panel contain a message about the irregularity of the plant, the operator is also warned when defined limit values for defined parameters are exceeded. The operator evaluates the relevance of the message and takes action where necessary.

1.3 Staff Qualification

Risks to users, property, and the environment can arise when the plant is used carelessly or improperly.

1.3.1 Responsible Body

- The head of related department is the responsible body.
- This operation & maintenance manual is to be stored where it is easy to access in close proximity to the plant and must be made available at all times to the operating personnel.
- Operators must be trained before handling and operating the plant. The head of department is the responsible for training his personnel. Only adequately qualified operators must be permitted to work with the plant under the supervision of the responsible body.
- Check that the operators have read and understood the operation manual. Define precise responsibilities of the operators.
- System settings of the plant are protected via passwords on the touchscreen operating panel and are shared only with the responsible body by the manufacturer. The responsible body must not share those passwords with anyone.
- The plant meets the recognized safety standards. Integration into a system may give rise to hazards that are **characteristic of the other system's design** and beyond the control of Unopex. It is the responsibility of the responsible body to ensure that the overall system, into which this plant is integrated, is safe.
- The responsible body must check whether local, national and federal regulations require any mandatory installation of further pollution control equipment for the plant/the entire system.
- Personal protective equipment must be provided to the operators.

1.3.2 Operators

- Work on the plant is reserved for appropriately qualified specialists, who have been assigned and trained by the responsible body to do so.
- Operators have to confirm by signature that they have carefully read and understood the operation manual.
- Operators must be at least 18 years old. The operator is responsible vis-a-vis third-parties in the work area before operating the plant.
- Legal regulations, such as local, national and federal laws applying to the plant, installation and working area of the plant must be strictly followed.
- Ensure that the plant is operated in proper condition only.
- Observe all safety instructions and do not ignore, bypass, dismantle or disconnect any safety devices.
- When working with the plant, always wear appropriate personal protective equipments (e.g. protective clothing, protective gloves, protective eye goggles, protective mask, non-slip shoes). The personal protective equipment must meet all requirements of all data sheets for the materials used. Choose and use adequate measures according to the applications, since some additional protective measures might be necessary.
- Modifications to the plant and modifications to the spare parts used are only permitted with the prior written approval of the manufacturer. The manufacturer will decline any claim resulting from unauthorized modifications. Ensure that modifications and upgrades are carried out by authorized Unopex specialists only.
- Ensure that service, repairs or maintenance work are carried out with care and on schedule and by specialists trained by the manufacturer only.

2. Technical Details

2.1 Scope of Delivery

Unopex UHM 20 Vacuum Mixer is delivered with complete standard components.

The content of the delivery is listed in the packing list. The completeness of the consignment has to be checked upon receipt.

In case of any damage and/or missing parts, prepare a status report and send it to Unopex Customer Service immediately.

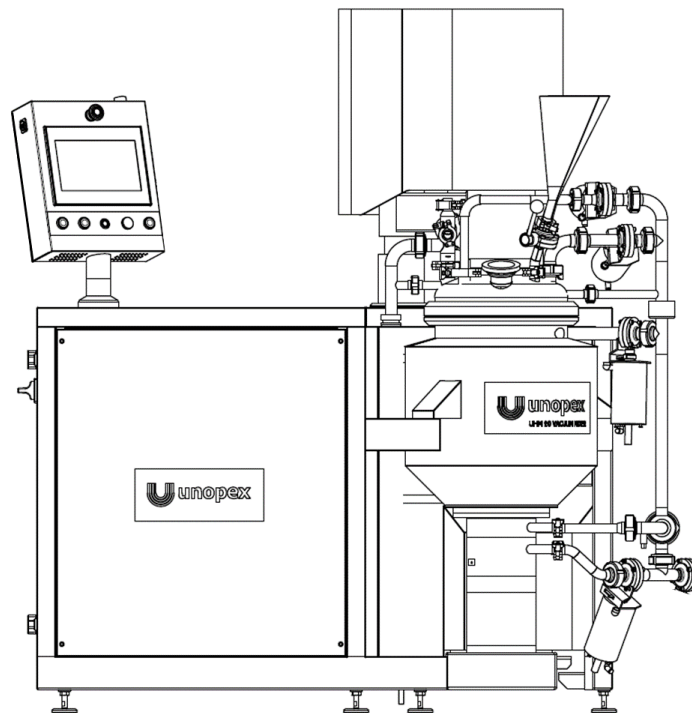
**INFORMATION**

For detailed product information, visit www.unopex.com or contact Unopex.

INFORMATION

Scope of delivery might change according to specific offers/quotations.

2.2 Technical Data

model	Unopex UHM 20 Vacuum Mixer
serial number	81686
production year	2025
min. usable working volume	3 L
max. usable working volume	20 L
max. product temperature	80 °C
ambient conditions	for indoor use only, temperature: 5–40 °C
operating pressure	-730 ... 0 mmHg (-973 ... 0 mbar), adjustable vacuum
heating	direct heating with electrical resistances 18 kW, PID controlled
cooling	indirect cooling with heat exchanger
external mixer	variable speed between 20 and 90 rpm, with chemically coated polytetrafluoroetilen (PTFE) scrappers
internal mixer	variable speed between 43 and 70 rpm
homogenizing turbine	variable speed between 600 and 3000 rpm
lid lifting system	hydraulic
feed hopper	for feeding raw materials, volume 1 L
thermal insulation	rockwool
compressed air requirement	5 ... 7 bar
surface quality of the vessel	mirror polished inner and outer surfaces
connection voltage, frequency	380 V AC, 50 Hz
operating panel	10.1" touchscreen
computer connection	data transfer with usb flash drive
Dimensions, lid closed (LxWxH)	1800x1000x1750 mm
Dimensions, lid open (LxWxH)	1800x1000x2200 mm

2.3 Material of Construction

product contact parts	stainless steel, AISI 316L
product non-contact parts	stainless steel, AISI 304
scrappers	chemically coated polytetrafluoroetilen (PTFE)

3. Plant Description

3.1 Overview

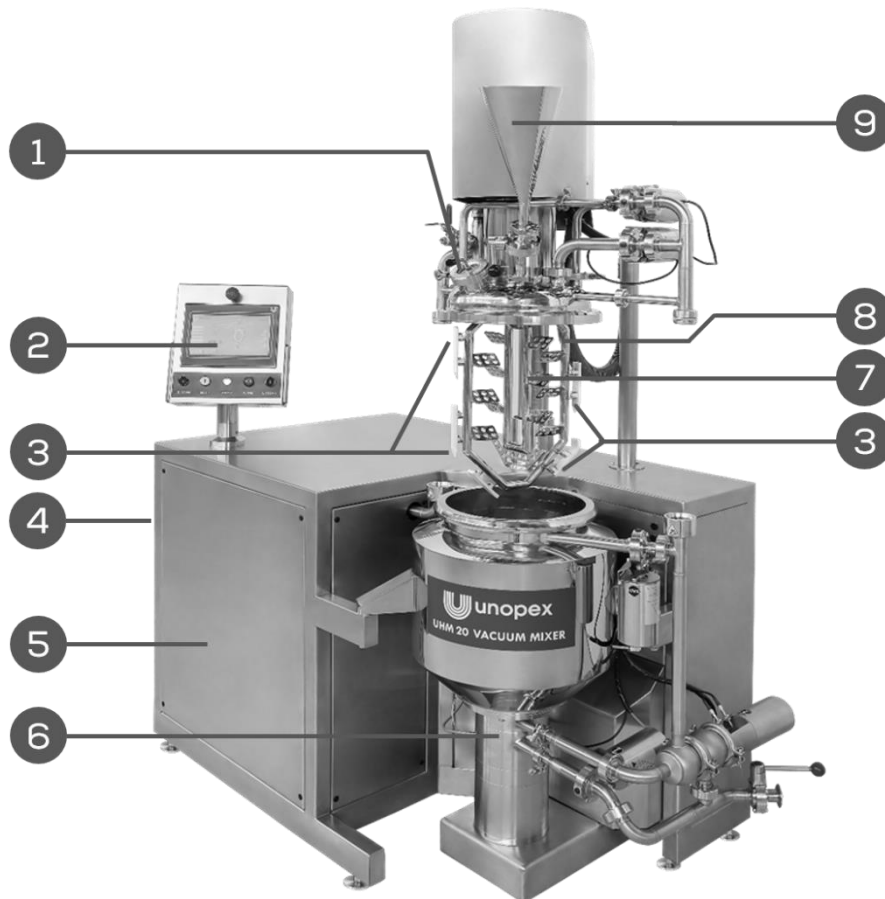

1	inspection glass with illumination	6	homogenizer
2	touchscreen	7	internal mixer
3	scrappers	8	external mixer
4	main switch	9	feed hopper
5	control cabinet		

INFORMATION

Components and parts might change according to specific offers/quotations.

3.2 External Connections

(supply and return line connections)











- Compressed air supply
- Mechanical seal cooling supply/return
- Chiller cooling supply
- Chiller cooling return
- Heating/cooling circuit water supply
- Vacuum line exhaust/drain
- Vacuum tank water supply line

3.3 Control Cabinet

On the front surface of the control cabinet;

- **10.1" touchscreen operating panel**
- buttons for lifting and lowering the lid,
- signal indicators for control voltage and alarm,
- usb insert,
- emergency stop are placed.

4. Preparations Before Operation

 WARNING  	MORTAL DANGER <ul style="list-style-type: none"> ➤ Do not operate a damaged plant ➤ Do not operate the plant with unsuitable installation ➤ Please contact the Unopex Customer Support when needed
 WARNING  	Death or serious injuries by use in explosive environments <ul style="list-style-type: none"> ➤ Do not install or operate the plant in explosive environments ➤ Do not install or operate the plant with explosive mixtures ➤ Check all connections for correct installation before operation ➤ Directly withdraw released gases and gaseous substances ➤ Only operate the plant in sufficiently ventilated environments
 CAUTION   	SERIOUS INJURY <ul style="list-style-type: none"> ➤ Place the plant on stable, horizontal and vibration-free surface in an adequately dimensioned area ➤ Get help from others where you need for heavy parts/components of the plant ➤ Take special care when loading, transporting and unloading to avoid damages ➤ Do not move the plant while assembled ➤ Keep limbs out of moving parts/crushing zones ➤ Check for damages to glass parts ➤ Do not touch thin/sharp edges of the parts/components

4.1 Un-packing

- Check for damage to the packaging. Damage can indicate property damage to the plant or parts/components.
- Check for any transport damage when unpacking the plant or parts/components.
- If necessary, prepare a status report immediately and always contact your forwarding agent regarding the settlement of claims.
- Follow the instructions under "Chapter 8.2" for the disposal of packaging material.
- Keep the original packaging for future transportation.
- If the plant is not assembled immediately after delivery, store it with all electrical components in a vibration-free, frost-free area; place on a foundation (do not place directly on the ground) and cover to protect against penetration of dust and humidity.

4.2 Ambient & Installation Conditions

Consider the ambient conditions **under** "Chapter 2.2".

Take into consideration of the dimensions and weight of the plant. Be sure that the floor can withstand the weight of the plant with full product.

Install the plant upright on a stable, horizontal, anti-slippery and vibration-free surface where you can easily reach.

Maintain wall and ceiling clearance for adequate air exchange (dissipation of waste heat, supply of fresh air for the plant and work area). Do not operate the plant in an inadequately dimensioned area.

INFORMATION

Use required sealing rings and gaskets for each connection and consider the correct mounting directions.

Screw all threaded connections tightly.

4.3 Connecting to the Power Supply

NOTE



Risk of plant damage by wrong mains supply

- External mains supply must meet the voltage and the current specified on the name plate
- Check for sufficient grounding.

INFORMATION

Additional electrical safety measures might be necessary to meet local laws and regulation!

External power or emergency stop switches must meet the requirements of the related standards, be accessible at any time and clearly labeled.

External connections and extension lines must be provided with a grounded conductor lead and power cords must meet the input power requirements.

Mains plug must be accessible at any time to cut the power in case of emergency by unplugging,

Unopex UHM 20 Vacuum Mixer is equipped with flexible power cords. Connect the power cords to the mains supply meeting the proper voltage and current specified on the name plate. The mains circuit must handle the electrical load of the plant and must be equipped with all electrical safety measures including proper grounding. After the installation, electrical safety tests are recommended to verify safe system condition such as sufficient grounding. All electrical works may only be carried out by qualified personnel.

5. Operation

5.1 Final Check Before Operation

Carry out the following checks and safety warnings prior to each operation.

- Only adequately qualified personnel who have been adequately trained may work with the plant.
- Each person working on the plant for assembly, commissioning, operation or maintenance has to have read and understood the complete operation manual and has to be familiar with all devices, operating elements and their functions
- Legal regulations, such as local, national and federal laws and responsible **body's safety rules** applying to the plant, installation or working area must be strictly followed
- All measures must be taken to ensure safe and functional operation of the plant
- Personal protective equipment must be provided to the operators
- Operators must wear non-slip shoes and protective clothing, gloves, eye goggles and mask during operation
- Store this manual where it is easy to access in close proximity to the plant
- Initial checks and periodical inspections must be performed properly
- External pressure supply must always meet the plant specifications
- Check the plant for correct installation and assembling
- Check all parts, connections, hoses tubes and sealings for good condition and tight connection
- Check the lid for correct seat and tight connection
- Inspect all glass parts visually for possible damage
- Exchange worn out or defective parts or components immediately
- Close valves and clamp connections which are not necessary during operation with blind components
- Ensure that no uncontrolled pressure may be released from the plant which would endanger life and limb of users or third persons
- Do not open any valve when there is a residual pressure inside the plant
- Check the electrical connections
- Check for leakages by performing an initial run without sample material
- Check for connections for disposing the substances used for operation and cleaning of the plant
- Do not use compressed air to clean dusty parts
- All possibly hazardous substances and fumes have to be removed from the working area
- Exhausts leaving the plant have to be lead away instantly by a ventilation system which is equipped with safety devices and equipments to avoid health risk or contamination of the environment
- The plant must be supervised during operation to prevent any unauthorized person to cause any possible damage
- Inspect and report any changes to the plant concerning safety immediately
- Operate the plant only in perfect working conditions.

5.2 Introducing Operating Elements

5.2.1 Homogenizer

The homogenizer consist of a fast-spinning inner rotor with a stationary outer stator to homogenize samples through mechanical tearing and shear fluid forces. The product in the vessel can be homogenized and/or recirculated during operation.

5.2.2 Internal and External Mixers

Unopex UHM 20 Vacuum Mixer has been designed and manufactured for mixing of products that come up with various degree of viscosity under reduced atmospheric pressure. It is appropriate for batch production of emulsions, syrups, lotion, skin care products, ointment, semisolids and creams in pharmaceutical, cosmetics, food and chemical industries.

An external agitator with PTFE scrappers and an internal agitator enables mixing with bottom-up/top-down recirculation while a bottom mounted homogenizer enhances the shearing and mixing effect as well as giving homogeneous stability to the mixing components.

Rotation direction, rpm and the runtime for both external and internal agitators can be set separately on the touchscreen operating panel.

5.2.3 Heating and Cooling System

The integrated heating/cooling system of the Unopex UHM 20 Vacuum Mixer ensures a PLC controlled indirect heating and cooling of the product in the vessel to be processed. Water is the heating and cooling media. When the heater is activated on the touchscreen and the set temperature is higher than the product temperature, heating is carried out by electrical heating rods. When the cooler is activated on the touchscreen and the product temperature is lower than the set temperature, cooling is carried out indirectly by a heat exchanger and a regulating valve. Required safety devices are installed in the heating/cooling circuit.

NOTE



Always run homogenizer before activating heater or cooler in order not to allow the product to be damaged as a result of an excessively high temperature.

INFORMATION

Heating or cooling can not be activated without running water pump.

5.2.4 Vacuum System

When desired vacuum value is set on the touchscreen and the vacuum pump is activated, plant works in reduced atmospheres. Vacuum rate is PLC controlled with a regulating valve.

NOTE



The constant availability of water supply has to be ensured manually for the vacuum tank. Otherwise, dry-run of the pump may lead to its destruction.

5.3 Introducing Operating Panel

CAUTION



SERIOUS INJURY

- Keep limbs out of moving parts/crushing zones
- Before pressing the buttons to lower the lid, make sure that there is nothing between lid and vessel

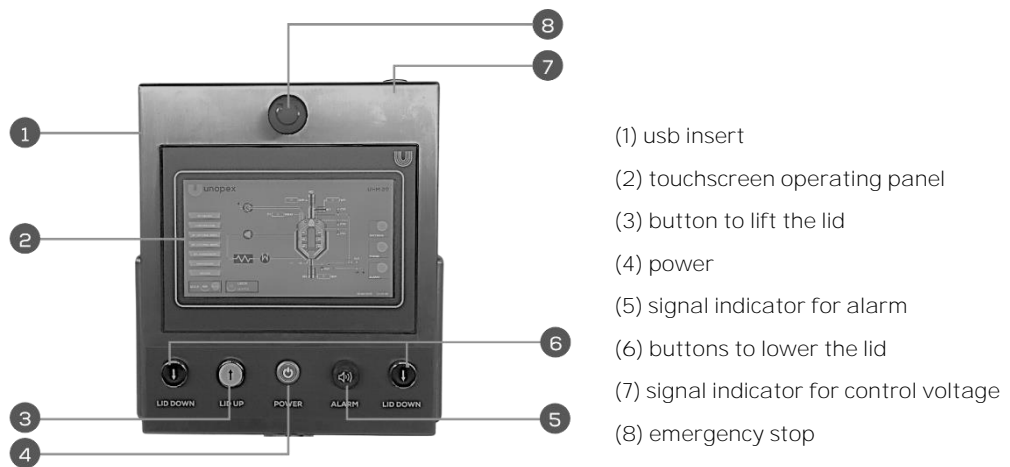

INFORMATION

For safety reasons, both buttons (6) at once should be pressed to lower the lid.

5.4 Introducing Touchscreen Operation

Touchscreen panel allows the user to operate the Unopex UHM 20 Vacuum Mixer in manual or auto mode. The recipe manager in the auto mode allows the user to achieve repeatability. All parameters for one step can be set and then be stored in total as a recipe which can always be repeated while operating the plant. It is possible to make 10 recipes with max. 30 steps each.

Manual mode

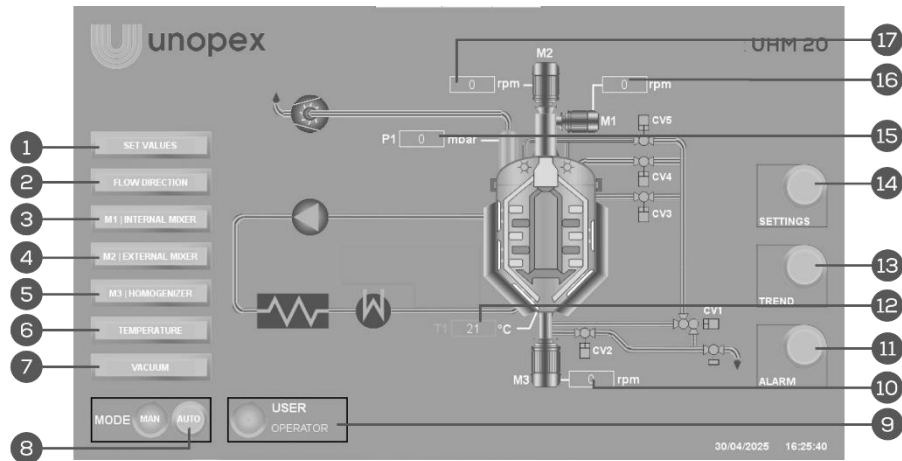

- (1) to make set values visible on the touchscreen for M1, M2, M3, T1 and P1.
- (2) to select the valve flow directions according to the desired operation

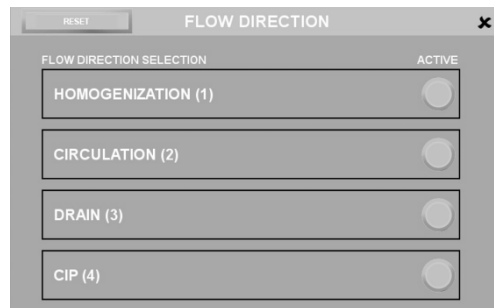

- (3) to start/stop and set the rotation time, direction and rpm for external agitator

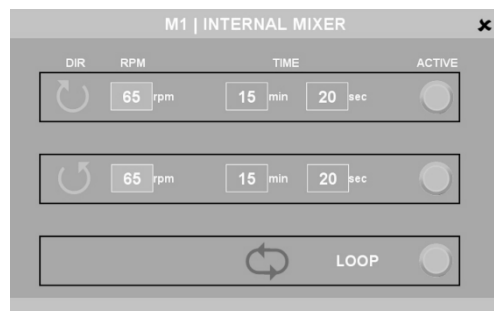

- (4) to start/stop and set the rotation time, direction and rpm for internal agitator



- (5) to start/stop and set the rpm for homogenizer



- (6) to set value and start/stop the temperature control
- (7) to set value and start/stop the vacuum control
- (8) to change the operating mode from manual to auto
- (9) to go to user log in/log out page
- (10) actual rpm value for homogenizer (M3)
- (11) to go to alarm page
- (12) actual temperature of the product in °C (T1)
- (13) to go to trend page (it is possible to see the process parameters during operation on the trend menu and to save the data to a usb flash drive)
- (14) to go to settings page
- (15) actual vacuum value for system in mbar (P1)
- (16) actual rpm value for internal mixer (M2)
- (17) actual rpm value for external mixer (M1)

Auto mode

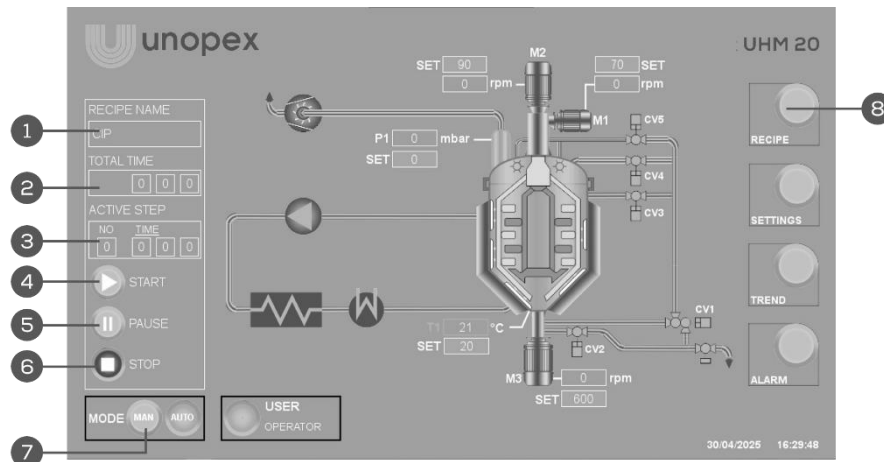

- (1) the name of recipe loaded
- (2) the current total time of the running recipe
- (3) the number and remaining time of the running step
- (4) to start the loaded recipe
- (5) to pause a running recipe (press again to allow the the recipe to continue)
- (6) to stop a running recipe
- (7) to change the operating mode from automatic to manual
- (8) to go to recipe manager page



5.5 Starting a Vacuum Mixing Operation

WARNING



MORTAL DANGER

When the plant is running, do not open or demount any clamps, pipelines, sensors etc. Open or close valves only according to the operating instructions.

1. Turn on the chiller unit.

INFORMATION

Chiller unit circulates a cooling medium and allows the heating/cooling circuit of the plant to be cooled indirectly to the desired temperature. Turn on the chiller at the beginning of each operation to allow itself to cool down.

2. Turn on the main switch. The control voltage signal indicator will be green.
3. Switch on the power on the control cabinet, welcome screen will appear on the touchscreen.

INFORMATION

Make sure that compressed air and chiller cooling medium supply lines are properly connected to the plant and the MV1 manual valve is closed.

Close valves and clamp connections which are not necessary during operation with blind components.

4. Open the manual valves for compressed air supply and chiller cooling lines.
5. Open the valve for vacuum tank water supply to feed sufficient water to the vacuum pump during operation.

NOTE



The constant availability of water supply has to be ensured manually for the vacuum tank. Otherwise, dry-run of the pump may lead to its destruction.

6. Select user and log in to the system on the touchscreen.
7. **Check system status by pressing the "SETTINGS"** on the touchscreen and make sure that all variables are normal.

NOTE



If any of the variables is not normal, fix it before operating the plant. Operate the plant only in perfect working conditions.

8. Open the manual MV3 valve slowly and carefully to deaerate the plant.
9. Fill in the vessel with the raw materials to be processed. Raw materials should be dosed into the vessel slowly via manual valve MV2 connected to the feed hopper.

INFORMATION

Always fill in the vessel with raw materials while the plant is NOT in operation. Minimum working volume of the vessel is 3 liters, maximum is 20 liters.

NOTE

Always fill in powder when there is liquid in the vessel. Dry powder will lead to damages to the homogenizer. Always fill in powder from a well dried feed hopper by opening the manual valve MV2 slowly. Pre-melt hardened raw materials to liquids in melting tanks before feeding into the vessel. Solid or hardened materials damages the plant.

10. Close the manual MV3 valve.
11. Select the operating mode (manual or automatic) on the touchscreen.

NOTE

For safety reasons, during operation of the plant either in manual or automatic mode, the operator should not leave the working area.

INFORMATION

The process parameters (temperature, vacuum, homogenizer rpm, rotation directions and rpm of internal and external mixers, valve flow directions etc.) should be adjusted and optimized by the operator according to the requirements of the raw materials and product.

INFORMATION

Operating the plant in manual or automatic mode are described under "Chapter 5.3".

5.6 Finishing a Vacuum Mixing Operation and Draining the Product

CAUTION

RISK OF BURNINGS WHEN HANDLING HOT PRODUCT OR SURFACES

- Do not allow hot raw materials or products to spurt out and cause severe burnings
- Do not touch hot surfaces
- Always wear proper personal protective equipments when working with the plant
- Allow all hot parts to cool down after operation

1. Turn off the temperature control on the touchscreen operating panel.
2. Turn off the vacuum control.
3. Select the valve flow direction DRAIN on the touchscreen.
4. Activate any of the first two (3.1 or 3.2) selections for draining in the flow direction selection menu. (If you need to drain with pressurization of the vessel, activate any of the last two (3.3 or 3.4) in the same menu. Make sure that the manual valve MV3 is closed, supply air according to the requirements of the raw materials and product to the system slowly and carefully via manual valve MV4. Do not allow the system to be pressurized more than 300 mbar.)

INFORMATION

Vacuum system should not be turned on if the drain is active in the flow direction menu.

5. Run the homogenizer at the minimum rpm.
6. Open the manual valve MV1 slowly and carefully to drain the product into a collection tank.
7. Repeat step 4 if needed to complete full drain.
8. Close MV1.

INFORMATION

It is possible for the operator to make product drain via recipe manager.

INFORMATION

Carry out cleaning of the plant immediately after each operation.

5.7 Cleaning

CAUTION

RISK OF BURNINGS WHEN HANDLING HOT LIQUID OR SURFACES

- Do not allow cleaning liquid to spurt out and cause severe burnings
- Do not touch hot surfaces
- Always wear proper personal protective equipments when cleaning with the plant
- Allow all hot parts to cool down after operation

NOTE

- Use soapy water as detergent only
- Acid or chlorine solutions must never be used

1. Fill in the vessel with water approx. 10 liters.
2. **Heat the vessel to approx. 50...80 °C.**
3. Activate CIP SHORT LINE (4.1) in the flow direction menu on the touchscreen.
4. Run the homogenizer (600...2000 rpm), **external agitator (20...50 rpm)** and internal agitator (43...60 rpm) for 5-15 minutes.
5. Activate CIP LONG LINE (4.2) in the flow direction menu.
6. Repeat step 4.
7. Activate DRAIN WITH HOMOGENIZATION (3.1) in the flow direction menu.
8. Open the manual valve MV1 slowly and carefully to drain the cleaning liquid into a waste collection tank.
9. Close the manual valve MV1.
10. Repeat step 1 and 2 respectively.
11. Activate CIP FULL (4.3) in the flow direction menu.
12. Repeat step 4.
13. Activate FULL DRAIN WITHOUT PRESSURE (3.2) in the flow direction menu.
14. Repeat step 8.
15. Close MV1.

INFORMATION

It is possible for the operator to make cip cleaning of the vessel via recipe manager.

6. Maintenance and Repairs

WARNING



DEATH OR SERIOUS INJURIES

- Depressurize the system before maintenance and repairs
- Wear proper protective equipments

WARNING



DEATH OR SERIOUS BURNING

- Switch off the plant, disconnect the power cord and prevent unintentional restart before maintenance and repairs
- Do not spill any liquids over any electronic parts or components
- Do not touch parts inside the plant with wet hands
- Do not squeeze cables, hoses or other items at reassembling
- Exchange defective cabling or hoses before reassembling

CAUTION



Always wear the following personal protective equipments when working with the plant

- protective clothing
- protective gloves
- protective eye goggles
- protective mask

Depending on operating conditions, noise levels might arise which can lead to deafness, loss of balance or reduced attention. Consider local noise regulations and use the proper personal protective equipment for ears.

CAUTION



Risk of minor or moderate burnings

- Some components can get hot during operation. Do not touch hot surfaces.
- Allow all hot parts to cool down before maintenance and repairs.

Ensure that the following check and maintenance works are carried out with care and on schedule and by specialists trained by the manufacturer only.

- Check cleanliness of the plant after each operation.
- Check the level of mechanical seal water tank for leakages; check scrappers for removing any unintended particles daily.
- Check safety devices (safety valves, switches etc.) monthly.
- Check all screw connections manually for tightness; check all cables, flexible pipes and hoses on damage and ageing; check scrappers on wear every three months.

- Calibrate measuring instruments every year.
- Check all gaskets of screwed connections for leakages and change every two years or earlier if necessary.
- Replace all pneumatic/hydraulic hoses and hydraulic oil in approximately five years or earlier if necessary.

Modifications to the plant and modifications to the spare parts used are only permitted with the prior written approval of the manufacturer. The manufacturer will decline any claim resulting from unauthorized modifications. Ensure that modifications and upgrades (including software modifications) are carried out by authorized Unopex specialists only.

Only use original spare parts which correspond to the technical requirements defined by the manufacturer.

6.1 Customer Service

Service and repair or maintenance work on the plant must be performed with care by authorized personnel only. These authorized personnel have a comprehensive technical training and knowledge of possible dangers which might arise from the plant and components.

Contact Unopex customer service for spare parts delivery, repairs or technical advice. Contact information is given on the website www.unopex.com.

7. Troubleshooting

7.1 Alarm Messages and Remedy

Alarm Number	Alarm Description	Possible cause	Remedy
ARM 101	Water Pump (WP) failure !	Blockage in the heating/cooling circuit	Localize blockage and clean it
		Dry run protection is active	See remedy for ARM 113
		Defective wiring	Check wiring of flow switch and pump
		Defective switch or pump	Contact Unopex customer service
ARM 102.1	P1 pressure is high !	Manual valve V3 is open	Close the valve
		T1 product temperature is too high	Cool the product Modify recipe
		Medium in the vessel is too much	Check the substances Modify recipe
		Pressure rise due to chemical reactions	Check the substances Modify recipe
		Defective wiring	Check wiring of pressure sensor (P1)
		Defective sensor or control valve	Contact Unopex customer service
ARM 102.2	P2 pressure is high !	Over pressurized flow in the heating/cooling circuit	Check the pressure, if it is more than 1 barg drain water from the line
		Insufficient flow in the heating/cooling circuit	Check the water level in the expansion tank Check leakage, localize and fix it
		Defective wiring	Check wiring of pressure sensor (P2)
		Defective pressure sensor	Contact Unopex customer service
ARM 103.1	T1 temperature is high !	Temperature rise due to chemical reactions	Cool the product Modify recipe
		Defective temperature sensor	Contact Unopex customer service

Alarm Number	Alarm Description	Possible cause	Remedy
ARM 103.2	T2 temperature is high !	High temperature in the heating/cooling circuit	Start cooling to lower the temperature
		Defective temperature sensor	Contact Unopex customer service
ARM 104.1	T1 temperature is too high !	Temperature rise due to chemical reactions	Cool the product Modify recipe
		Defective temperature sensor	Contact Unopex customer service
ARM 104.2	T2 temperature is too high !	High temperature in the heating/cooling circuit	Start cooling to lower the temperature
		Defective temperature sensor	Contact Unopex customer service
ARM 105.1	CV1 valve failure !	No compressed air supply	Make sure that the compressed air is supplied to the valve
		Compressed air connection configuration is incorrect	Make the hose-valve connections in correct configuration
		Air leakage	Check compressed air line through control valve connection, detect leakage and remove it
		Valve cannot reach its final position	Check valve seal, replace if necessary
		Defective wiring	Check wiring of the solenoid valve and valve sensors
		Defective control valve, solenoid valve or valve sensors	Contact Unopex customer service
ARM 105.2 ... 5	CV2 ... CV5 Control Valve failure !	No compressed air supply	Make sure that the compressed air is supplied to the valve
		Compressed air connection configuration is incorrect	Make the hose-valve connections in correct configuration
		Air leakage	Check compressed air line through control valve connection and check valve seal, detect leakage and remove it
		Valve cannot reach its final position	Check valve seal, replace if swollen
		Defective wiring	Check wiring of the control valve, solenoid valve and valve sensor
		Defective control valve, solenoid valve or valve sensor	Contact Unopex customer service

Alarm Number	Alarm Description	Possible cause	Remedy
ARM 105.2 ... 5	CV2 ... CV5 Control Valve failure !	No compressed air supply	Make sure that the compressed air is supplied to the valve
		Compressed air connection configuration is incorrect	Make the hose-valve connections in correct configuration
		Air leakage	Check compressed air line through control valve connection and check valve seal, detect leakage and remove it
		Valve cannot reach its final position	Check valve seal, replace if swollen
		Defective wiring	Check wiring of the control valve, solenoid valve and valve sensor
		Defective control valve, solenoid valve or valve sensor	Contact Unopex customer service
ARM 106.#	T# temperature sensor failure !	Defective wiring	Check wiring of the sensor Switch off the plant and try again
		Defective sensor	Contact Unopex customer service
ARM 107.#	P# pressure sensor failure !	Defective wiring	Check wiring of the sensor Switch off the plant and try again
		Defective sensor	Contact Unopex customer service
ARM 108.1	M1 motor failure !	Safety protection while vessel lid open is active	Check the vessel lid, close it before starting agitation
		Overload of motor drive due to not pre-melted raw materials or hardened products	Clean plant & unblock the agitators immediately
		Defective wiring	Check wiring of motor and vessel lid sensors
		Defective motor or vessel lid sensors	Contact Unopex customer service

Alarm Number	Alarm Description	Possible cause	Remedy
ARM 108.2	M2 motor failure !	Safety protection while vessel lid open is active	Check the vessel lid, close it before starting agitation Check sensors for vessel lid
		Overload of motor drive due to not pre-melted raw materials or hardened products	Clean plant & unblock the agitators immediately
		Defective wiring	Check wiring of motor and inductive sensors
		Defective motor	Contact Unopex customer service
ARM 108.3	M3 motor failure !	Safety protection while vessel lid open is active	Check the vessel lid, close it before starting homogenization Check sensors for vessel lid
		Dry run protection is active	See remedy for ARM 109.1
		Overload of motor drive due to not pre-melted raw materials or hardened products	Clean plant & unblock the homogenizer immediately
		Defective wiring	Check wiring of motor and inductive sensors
		Defective motor	Contact Unopex customer service
ARM 109.1	Level in mechanical sealing water tank is low !	Water leakage	Check leakage, localize and fix it
		Defective wiring or switch	Check wiring of the level switch Switch off the plant and try again
			Contact Unopex customer service
ARM 109.2	Level in expansion tank is low !	Water leakage	Check leakage, localize and fix it
		Defective wiring or switch	Check wiring of the level switch Switch off the plant and try again Contact Unopex customer service
ARM 110	Hydraulic lift failure !	Defective wiring, switch or pump	Contact the Unopex customer service
ARM 111	VP Vacuum Pump failure !	Defective wiring or pump	Contact Unopex customer service







Alarm Number	Alarm Description	Possible cause	Remedy
ARM 112	Heating controller failure !	Defective heating controller	Contact Unopex customer service
ARM 113	P2 pressure is too low !	Water leakage in the heating/cooling line	Check leakage, localize and fix it Contact Unopex customer service
ARM 114	No Flow! Water Pump is stopped !	No flow in heating/cooling circuit	See remedy for ARM 101
ARM 115	Emergency Stop is active !	Activated emergency stop push button Defective switch	Release the button Contact Unopex customer service

7.2 Malfunctions and Remedy

Malfunction	Possible cause	Remedy
Plant cannot be switched on	No voltage	Insert mains plug Turn on the main switch Contact Unopex customer service
	Plant does not heat up	Temperature control is not turned on Turn on the temperature control T1 set point is below the product temperature Set a new temperature above product temperature Homogenizer (M3) is not turned on Run homogenizer when the heater is active Defective wiring of heating elements Check wiring of heating elements Polluted heating/cooling circuit Contact Unopex customer service Heater defective Contact Unopex customer service
	Plant does not cool down	Chiller unit is not turned on Turn on the chiller unit Temperature control is not turned on Turn on the temperature control T1 set point is above the product temperature Set a new temperature below product temperature Homogenizer (M3) is not turned on Run homogenizer when the heater is active Cooling water is warm Reduce cooling water temperature Cooling water supply is not sufficient Open cooling water supply valve Polluted heating/cooling circuit Contact Unopex customer service
Plant does not achieve the set vacuum values	Incorrect seat of lid	Check the lid for correct seat and tight connection
	Open valve or clamp connection	Close valves and clamp connections which are not necessary during operation with blind components
	"Drain" is active in flow direction menu	Activate another selection in the flow direction menu on the touchscreen
	Leakage	Check all parts, connections, hoses tubes and sealings for good condition and tight connection, exchange worn out or defective parts or components
Raw material cannot be fed into the vessel	Sealing material incompatibility	Check compatibility/corrosion resistance of sealing material
	Manual valve MV2 is blocked	Clean the possible powder block at feed valve If the valve is moist, dry the valve and sealing well, feed powder more slowly
	Leakage at manual valve MV2	Check the sealing of feed valve, replace if defective Contact Unopex customer service

8. Taking Out of Operation

 WARNING	<p>Death or serious poisoning by contact or incorporation of harmful substances</p> <ul style="list-style-type: none"> ➤ Wear appropriate personal protective equipments (e.g. protective clothing, protective gloves, protective eye goggles, etc). ➤ Remove all liquids and dusty residues from the plant to remove possibly dangerous substances ➤ Do not use compressed air for removing dusty residues
--	--

8.1 Storage, Packing and Transport

Switch off the plant, remove the power cord, clean the plant thoroughly.
Store the plant and its components in a dry location.

INFORMATION	When returning a component of the plant to the manufacturer for repair work, visit www.unopex.com and download the safety clearance form, then complete and send it with the component.
--------------------	---

8.2 Disposal

For environmentally friendly disposal of the plant, do comply with all regional and local disposal regulations applicable for you.

INFORMATION	Contact your local authorities for any questions concerning disposal.
--------------------	---

9. Declaration of Conformity



Declaration of Conformity

Directives 2006/42/EC (machinery directive)
2014/35/EU (low voltage directive)

Manufacturer BAK-ON Makina Muhendislik Ltd. Sti.
1429 Sk. No:9 Doğanlar
Izmir / Turkey

Certification FQC Standard Sertifikasyon Muayene
Laboratuvar Egitim Hizmetleri A.S.
Manisa / Turkey

Equipment Vacuum Mixer - Unopex UHM 50
Unopex UHM 2, Unopex UHM 5, Unopex UHM 10,
Unopex UHM 20, Unopex UHM 100, Unopex UHM 500

Standards EN 60204-1:2018, Safety of machinery- Electrical equipment
of machines- Part 1: General requirements

We hereby certify under our sole responsibility that the equipment described
herein has been manufactured and tested in accordance with the above
directives and standards.

Izmir, November 23th, 2022

Isil Saygan,
Quality Management



-  Izmir / Turkiye
 +90 232 479 80 17
 unopex@unopex.com
 www.unopex.com



© 2025
Failure to comply with this installation manual is deemed improper use.
Technical data and images are subject to change without notice.