

# Unopex B 15

## Mini Spray Dryer



# INTRODUCTION

Unopex is the pioneer brand of the spray drying technology in Turkey.

We design and manufacture spray dryers from lab scale research and development applications to full production scale.

The close cooperation with our customers ensures the development and implementation of the optimum project concept.

We develop innovative, smart and advanced technologies that satisfy our customers.

## Contents

● Introduction	2
● Technology	4
● Key Features	6
● Key Components	7
● Microencapsulation	8
● Configuration	9
● B 45 Dehumidifier	10
● B 60 Inert Cycle	12
● B 92 Spray Chilling	14
● Scale Up	15



## B 15 Mini Spray Dryer

Laboratory Spray Drying with maximized benefits

- Laboratory scale reproducible powder production
- Clear view of the process due to glass assembly
- Simple and fast installation
- Quick and easy operation
- Glass parts can be assembled and cleaned quickly by just one person
- Dehumidifier and Inert Cycle accessories for solvents and mixtures
- Lowest maintenance and spare parts costs
- Scale up to high product volumes

### Fields of Application

- Foodstuffs
- Milk and Egg Products
- Pharmaceuticals
- Nutraceuticals
- Flavours and Colourings
- Plant and Vegetable Extracts
- Cosmetics
- Biochemicals
- Fine Chemicals
- Ceramics and Advanced Materials
- Polymers and Resins

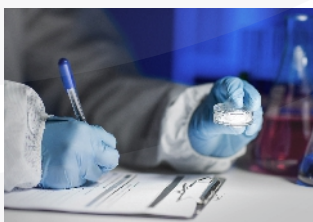

## B 15 Mini Spray Dryer

Unopex offers the perfect solution for the first trial spray dry processing, feasibility studies, process development and product researches.

Unopex B 15 Mini Spray Dryer is a laboratory equipment for quick and gentle drying of products from water or organic solvent based feeds.

### Technical Specifications

Model	Unopex B 15
Evaporating capacity	max. 1,5 L/h (water)
Drying air inlet temperature	max. 220 °C
Feed pump	peristaltic, variable speed
Configuration	co-current
Atomization system	2-fluid nozzle
Nozzle cleaning	automatic
Blower	variable speed
Material of construction	borosilicate glass, 1.4401, 1.4404
Heating power	3 kW, PID controlled
Connection voltage	220 V, 50/60 Hz
Operating panel	touchscreen
Computer connection	data transfer with ethernet or USB
Dimensions (LxWxH)	800x600x1400 mm
Accessories	inlet and outlet filters, safety curtain

### Working Principle

1. Solution or suspension is injected into the drying chamber through a nozzle.
2. Drying gas is heated and injected into the drying chamber.
3. The nozzle atomizes the solution into small droplets.
4. As the droplets of solution fall through the chamber, moisture evaporates from the droplets and they become particles.
5. The drying gas carries the particles to the cyclone where the particles are separated from the gas. Powder is collected.
6. The drying gas is filtered and exhausted.

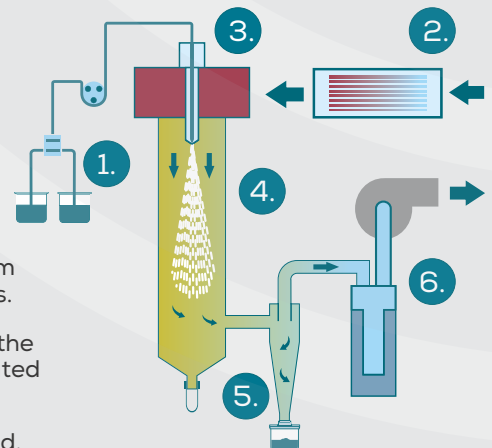

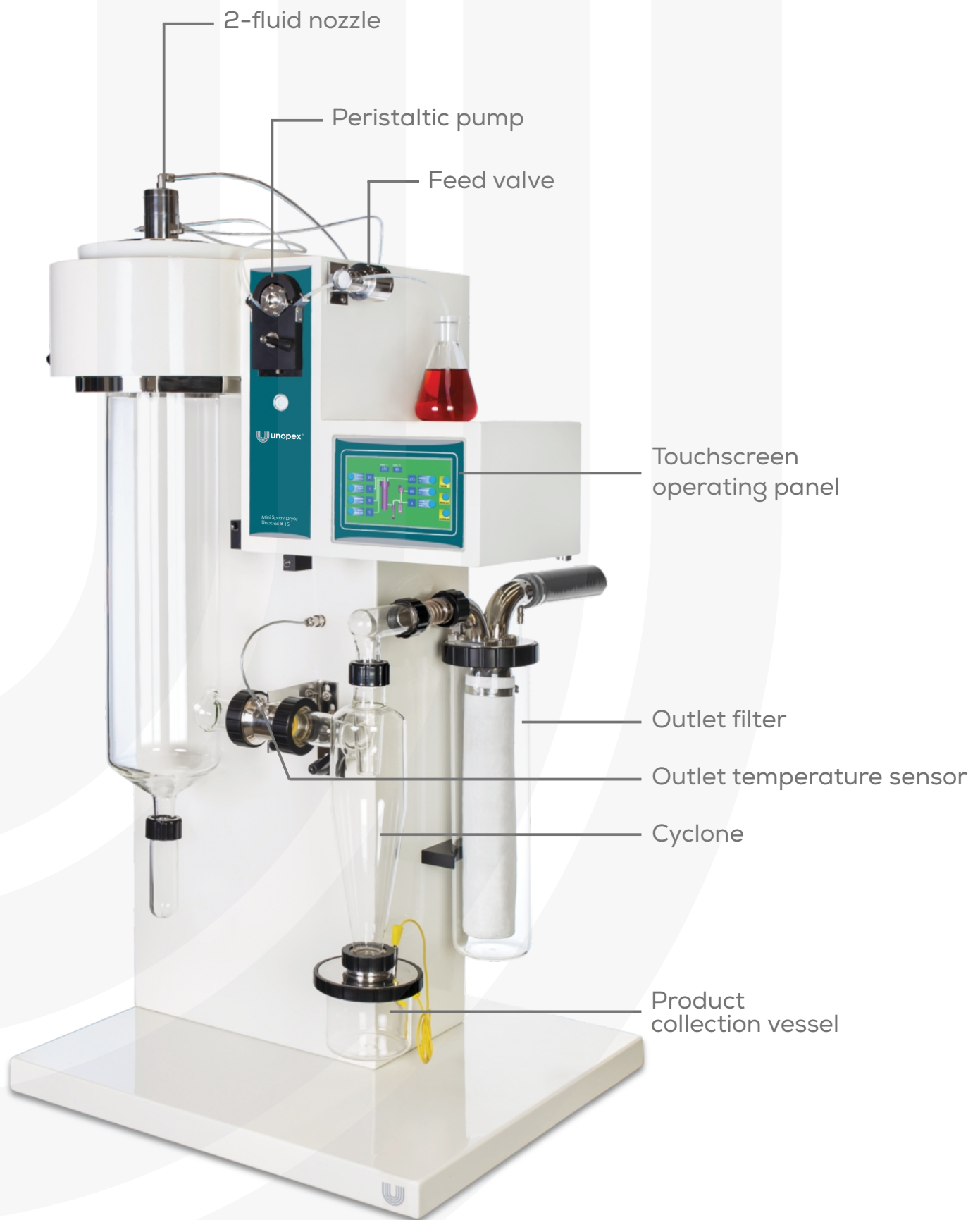

# KEY FEATURES

## B 15 Mini Spray Dryer

Laboratory Spray Drying for small samples and particles

- Spray drying, microencapsulation and spray chilling with one product
- Trouble-free spraying over long periods with 2-fluid nozzle
- Display and easy setting of process parameters
- Touchscreen operating panel
- Quick and gentle spray drying
- Automatic nozzle cleaning
- PLC controls
- Fast installation
- Automatic feed switch valve
- High performance cyclone
- Two different versions of the glass cylinders
- Safe operation with plexiglass safety curtain
- Outlet gas filter for the protection of users and the environment
- Plug and play
- CE compliant



## Key Components

Precisely tailored to your needs

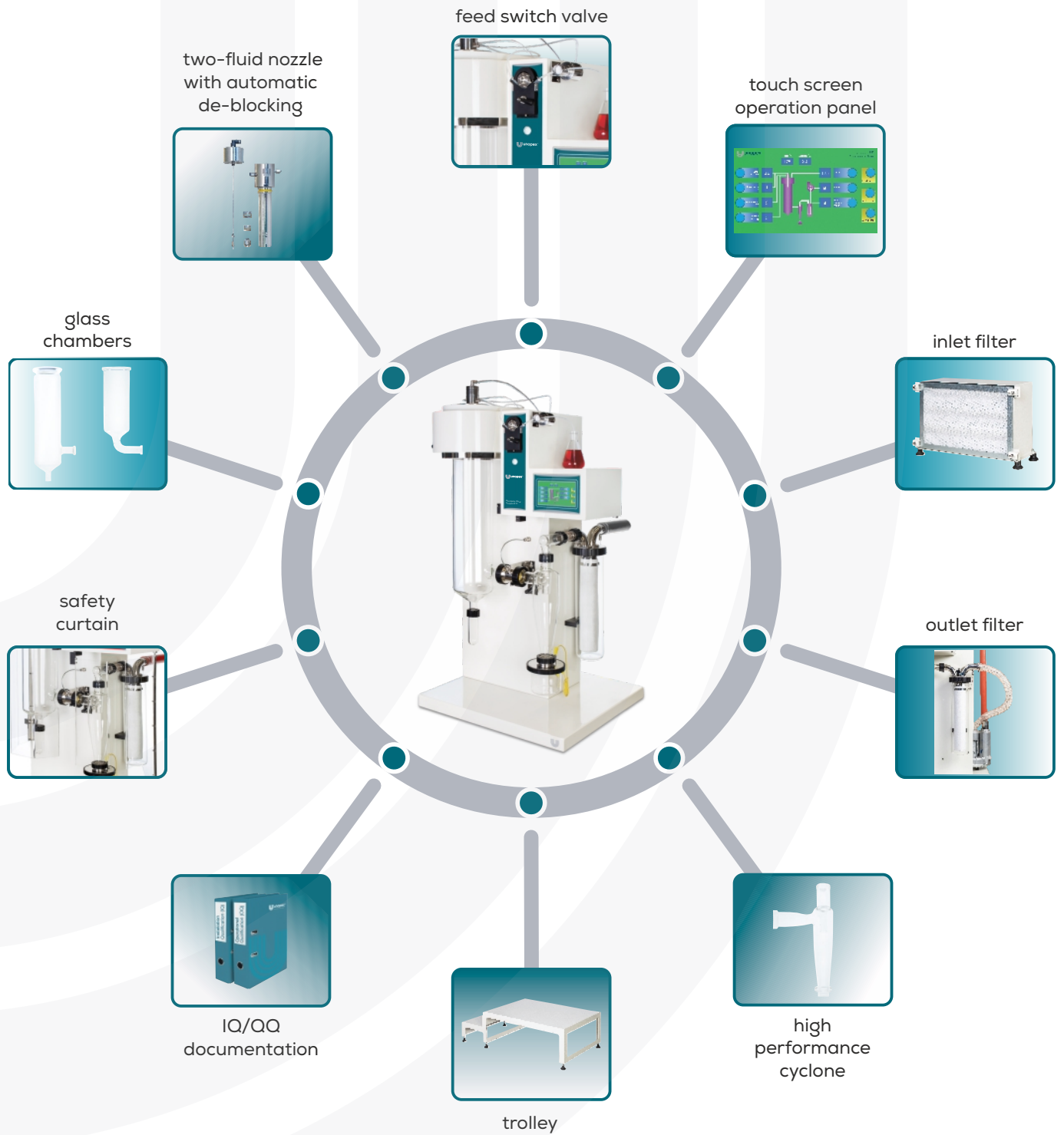

# MICROENCAPSULATION

## Microencapsulation

Spray drying can be used as a microencapsulation method.

In microencapsulation the product is mixed with a carrier and then spray-dried so that the carrier protects the product.



## Reasons for the use of microencapsulation

- protection of the product from surrounding environment (temperature, moisture, etc), protection from degradation or flavour loss, extension of its shelf life
- masking of the undesired properties (taste, odour) of the active material
- decrease of the evaporation of the active material to the outside environment
- controlled release of the active material under desired conditions
- conversion of liquids and sticky solids to free-flowing powders

## Process of encapsulation by spray drying

- The process starts with the preparation of a wall solution.
- The active core material is then added to the wall solution.
- The core/wall material mixture (emulsion or dispersion) occurs with a vigorous mixing.
- The mixture is fed into the spray dryer.
- In the spray dryer, the core/wall material mixture is transformed into droplets by nozzle atomizer and hot air flowing contacts the atomized particles and evaporates the water.
- The dried particles, consisting of dry matrices in which the core material is held in a micro dispersion, are separated from the gaseous medium in the cyclone and fall into the collection flask.

two-fluid nozzle

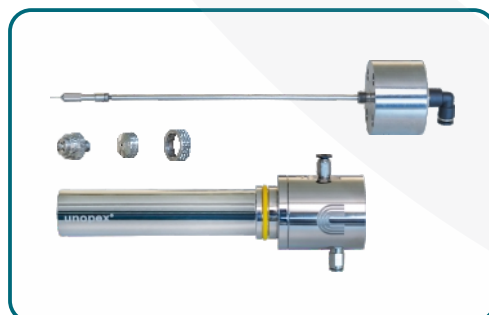

touch screen operation panel

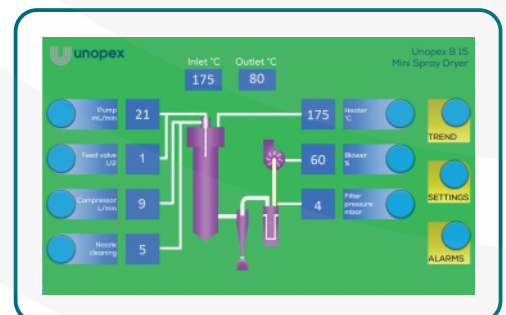

# Configuration

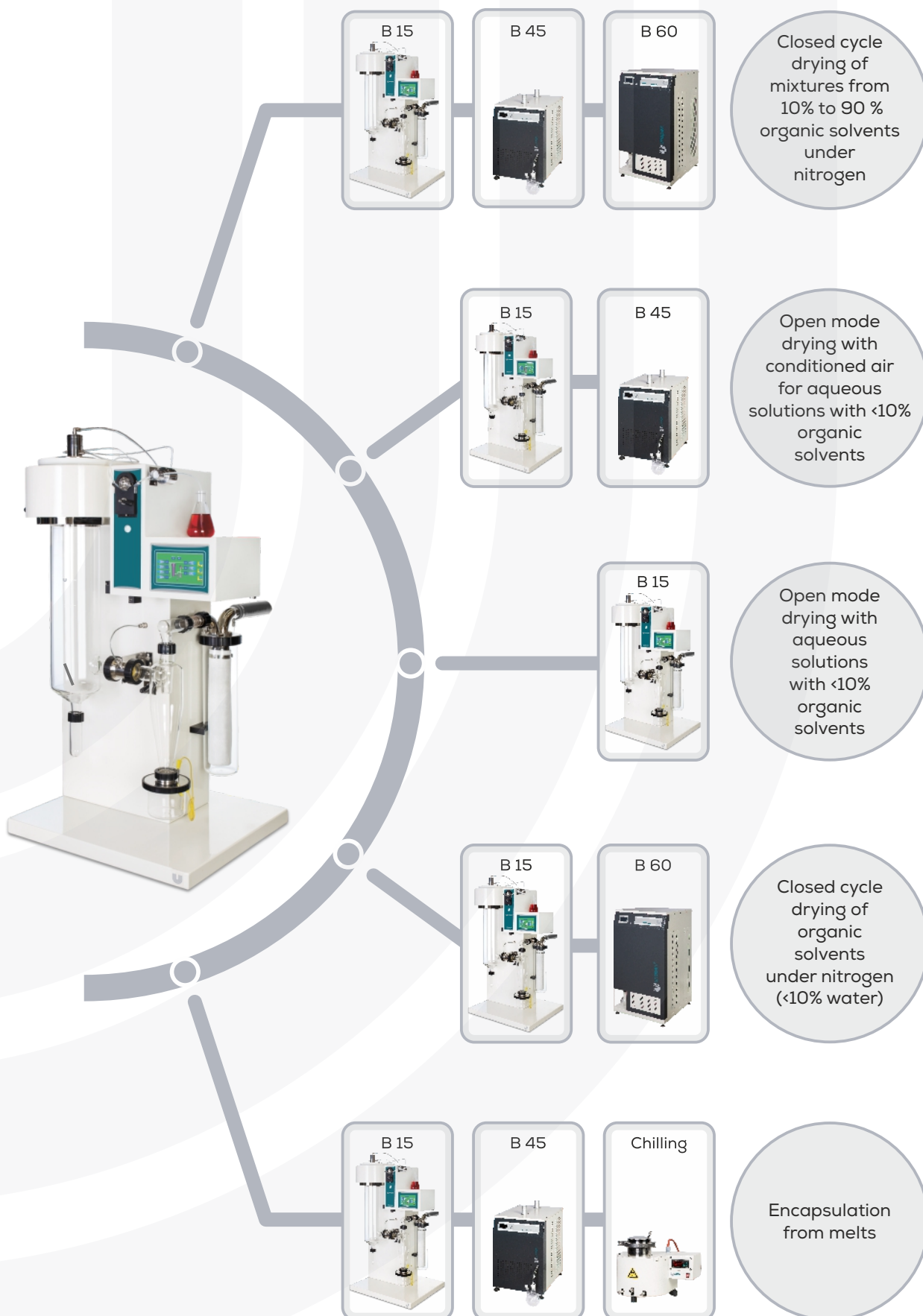

## B 45 Dehumidifier

Unopex B 45 Dehumidifier is a complementary accessory to condition drying air, to work continuously with water and organic solvent mixtures or inlet air cooling for the spray chilling operation.

Air humidity changes due to seasons and regions. The B 45 Dehumidifier guarantees drying under constant and reproducible humidity conditions.

Working with water/organic solvent mixtures in closed mode requires to use both B 45 Dehumidifier and B 60 Inert Cycle Organic Solvent Recovery Unit.

Unopex B 45 Dehumidifier is simply connected to B 15 Mini Spray Dryer with flexible tubes.

### Benefits

- improved spray drying capacity, constant and reproducible humidity conditions
- removal of more water per hour
- control and measurement of relative humidity
- enables to work with water/solvent mixtures in combination with Unopex B 60 Inert cycle



## Unopex B 45 Dehumidifier used in the closed mode

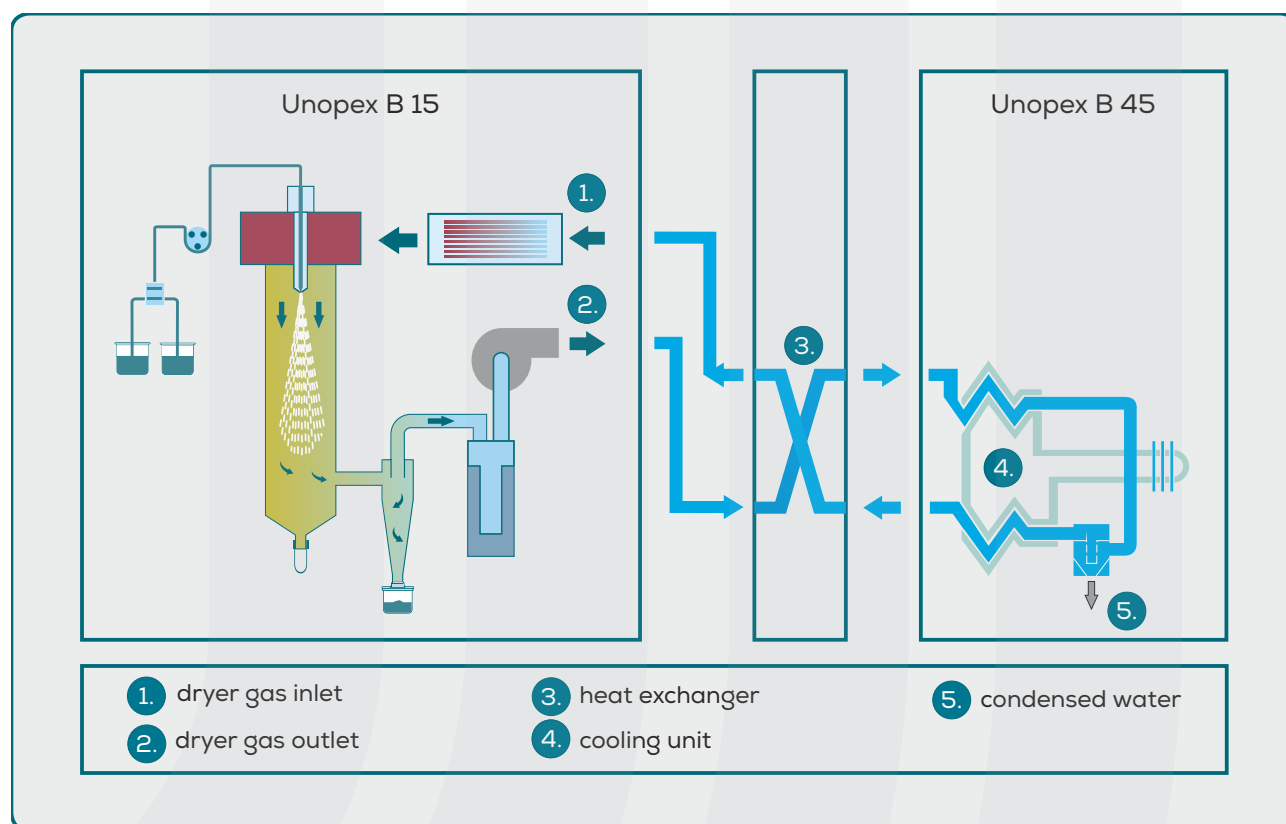

Unopex Heat Exchanger



## Technical Specifications

Cooling capacity	max. 1200 W
Minimum outlet temperature	0 °C
Electrical connection	220 V, 50/60 Hz
Dimensions (LxWxH)	450x550x700 mm
Weight	35 kg

## B 60 Inert Cycle

Organic Solvent Recovery Unit

Unopex B 60 Inert Cycle Organic Solvent Recovery Unit is a complementary accessory that enables to work with organic solvent-based formulations safely.

It is used to work in closed mode, under nitrogen atmosphere in combination with Unopex B 15 Mini Spray Dryers.

The Inert Cycle B 60 can be placed next to the Mini Spray Dryer B 15 and simply connected with flexible tubes to ensure their safe operation in closed mode.

Organic solvents are recovered in the closed mode to protect the users and the environment.

### Organic solvents

- ethanol
- methanol
- acetone
- ethyl acetate



### Benefits

- safe operation with 100% organic solvents under inert conditions
- minimal inert gas consumption due to closed mode
- safe and explosion free working conditions due to real time oxygen control
- hepa filters
- enables to work with water/solvent mixtures in combination with Unopex B 45 Dehumidifier

## Combined system diagram of the Unopex B 15 and B 60 Inert Cycle

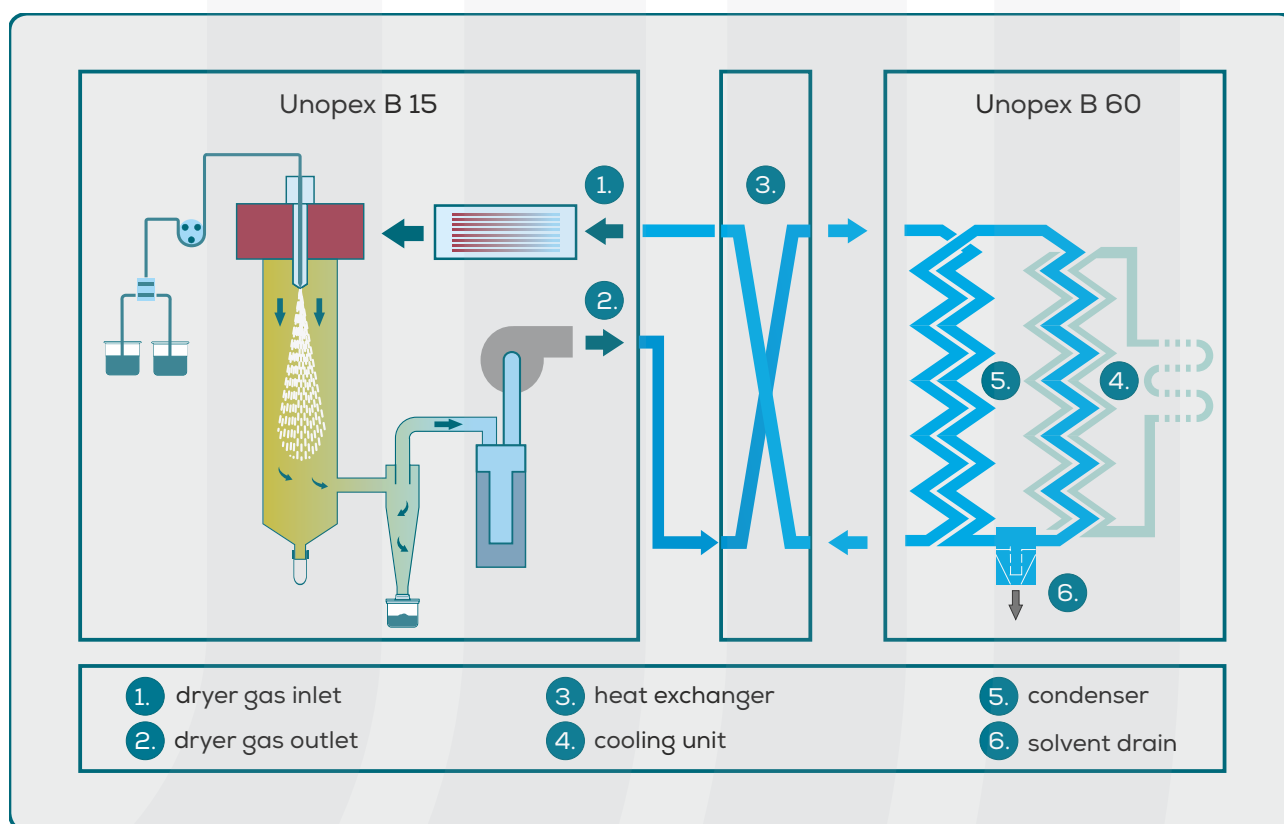

## Technical Specifications

Cooling capacity	max. 1,5 kW
Minimum outlet temperature	-25 °C
Electrical connection	220 V, 50/60 Hz
Dimensions (LxWxH)	700x800x1400 mm
Weight	95 kg

## B 92 Spray Chilling

Unopex Spray Chilling Unit is the ideal complementary accessory that enables to make powders directly from molten feed samples by solidification.



It is used to work in combination with Unopex B 15 Mini Spray Dryer and B 45 Dehumidifier.

The cooled gas moves in co-flow with the atomized feed in the process chamber where the droplets transfer their heat energy to the gas.

### Technical Specifications

Volume	0,5 liter
Heating capacity	800 W
Temperature control	digital, ( $\pm 1$ °C)
Melting temperature	max. 80 °C
Heating fluid	water
Electrical connection	220 V, 50/60 Hz

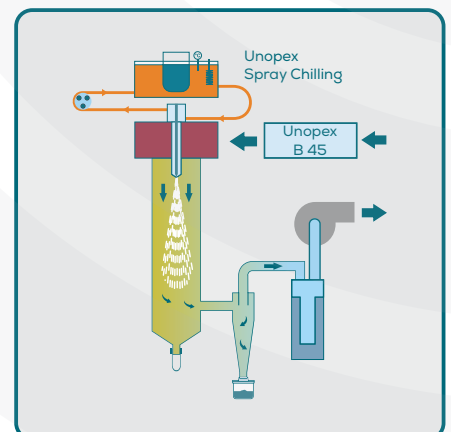
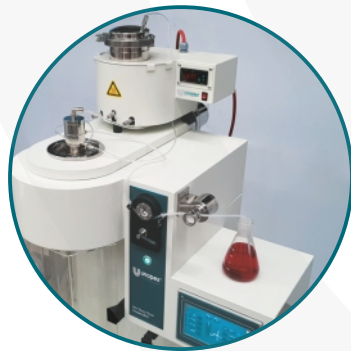

### Benefits

- Spray chilling at laboratory scale
- Easy installation on the top of the Unopex B 15 Mini Spray Dryer
- Electrical heater, temperature probe and metering valve
- Nozzle with heating jacket to prevent any blocking
- Digital control panel
- 2 separate feed vessels for continuous work

## Scale Up

Scale Up from Research to Pilot and Industrial Production Scale

A small spray dryer is particularly useful for initial trials.

Unopex B 15 Mini Spray Dryer is an ideal instrument for research and product development purposes.

The results from a successful spray drying test conducted on the Unopex B 15 Mini Spray Dryer can be utilized in the scale up procedure to Unopex B 230 Pilot Scale Spray Dryer and to industrial production.



**Unopex B 15**



**Unopex B 230**

Model	Unopex B 15	Unopex B 230
Evaporation Capacity	max. 1.5 L/h (water)	max. 6 L/h (water)
Drying gas max. inlet temperature	220 °C	250 °C (optional 350 °C)
Feed pump	peristaltic, variable speed	peristaltic, variable speed
Heater	electrical, 3 kW	electrical, 9 kW
Atomization system	nozzle	nozzle / rotary atomizer
Particle size range	1-25 µm	5-80 µm
Operating conditions	open, closed cycle	open, closed cycle



All rights reserved. U2010149.4, subject to change without notice.

- Izmir / Turkiye
- +90 232 479 80 17
- unopex@unopex.com
- www.unopex.com



unopex® is a division of BAKON